

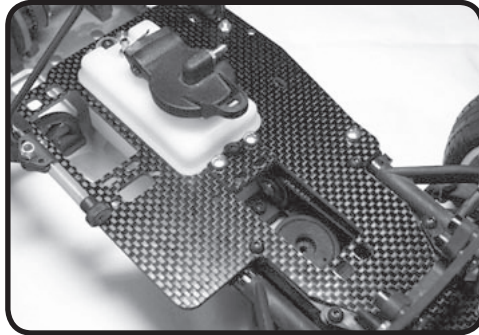

Summer 2006



Penguin *r/c*



P1712

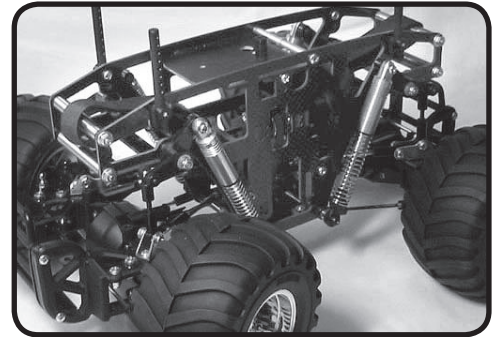

P2300

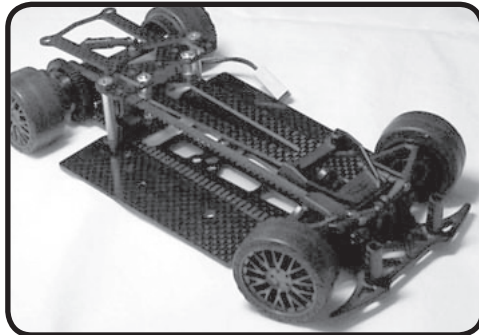

P3500lm

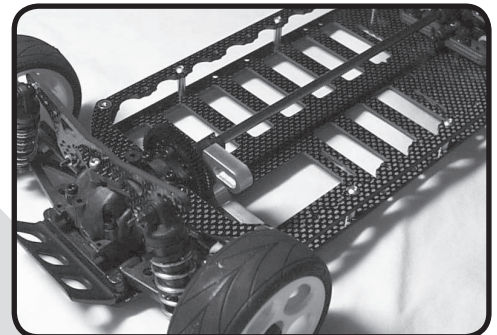

P5500

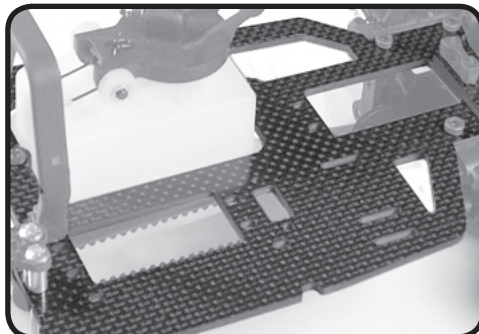

P6002

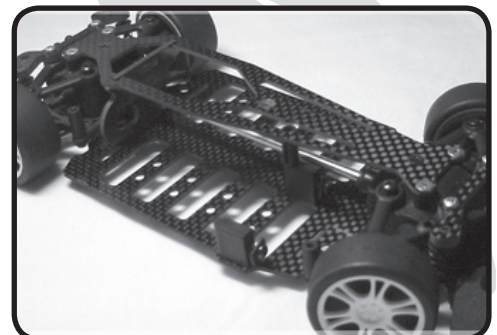

P7500



Associated

Items from a chassis set, replacement or optional parts list indicated with a "*" can be used directly upon the base car without the need of additional parts.

TC3

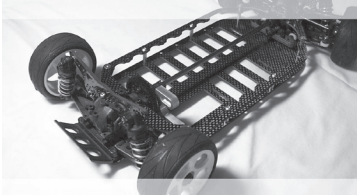

P5500tc3 Performance Chassis **Sale!!! \$149.99**

Replacement Parts

P5501tc3	P5500tc3 Main Chassis Plate	\$59.99
P5502a	P5500 Graphite Side Rail (x1)	\$19.99
P5502tc3*	P5500tc3/TC3 Corner Brace Set	\$18.99
P5503*	P5500/TC3/TC4 Auxillary Body Mount Kit	\$4.99
P5504a	P5500 Chassis Stiffener Kit	\$11.99
P5504b	P5500 Battery Post Kit	\$5.99
P5505tc3	P5500tc3 Aluminum Motor Mount	\$69.99
P5506tc3*	P5500tc3/TC3 Front Shock Tower	\$24.99
P5507tc3*	P5500tc3/TC3 Rear Shock Tower	\$24.99

Optional Parts

P5504a	P5500 Chassis Stiffener Kit	\$11.99
P5508	P5500 Nerf Wing Kit	\$8.99
P5509a	P5500 Velcro Battery Strap Set	\$13.99
P5712	Front Bumper/Arm Protector	\$6.99

Website information: <http://www.penguinrc.com/products/associated/p5500tc3.html>

TC4

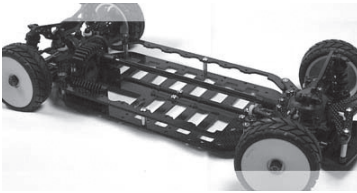

P5500tc4 Performance Chassis **\$129.99**

Replacement Parts

P5501tc4	P5500tc4 Main Chassis Plate	\$59.99
P5501tc4b	P5500tc4 Servo Adaptor Plate	\$3.99
P5502a	P5500 Graphite Side Rail (x1)	\$19.99
P5502tc4	P5500tc4/TC4 Corner Brace Set	\$19.99
P5502tc4a	P5500tc4/TC4 Camber Plate Set	\$15.99
P5502tc4b	P5500tc4/TC4 Camber Plate Spacer Set	\$11.99
P5503*	P5500/TC3/TC4 Auxillary Body Mount Kit	\$4.99
P5504a	P5500 Chassis Stiffener Kit	\$11.99
P5504b	P5500 Battery Post Kit	\$5.99
P5504tc4	P5500tc4 Battery Adjustment Plates	\$6.99
P5505tc4	P5500tc4 Center Shaft Support Kit	\$8.99

Optional Parts

P5504a	P5500 Chassis Stiffener Kit	\$11.99
P5506*	P5500tc4/TC4 Front Shock Tower	\$18.99
P5507*	P5500tc4/TC4 Rear Shock Tower	\$18.99
P5508	P5500 Nerf Wing Kit	\$8.99
P5509a	P5500 Velcro Battery Strap Set	\$13.99
P5714	Front Bumper Brace - TC4/NTC3	\$14.99

Website information: <http://www.penguinrc.com/products/associated/p5500tc4.html>

Other

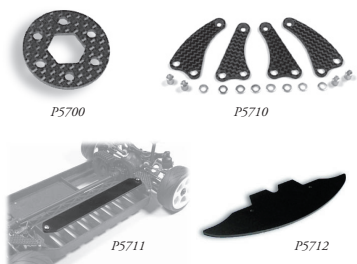

additional items for other vehicles

P5506*	P5500tc4/TC4 Front Shock Tower	\$18.99
P5507*	P5500tc4/TC4 Rear Shock Tower	\$18.99
P5700	Performance Brake Disc - RC10 GT	\$3.99
P5710	Graphite Corner Brace Set - TC3	\$17.99
P5711	Quick Release Battery Bar - TC3	\$5.99
P5712	Front Bumper/Arm Protector - TC3	\$6.99
P5713	Corner Barce and Camber Plate Set - TC4	\$14.99
P5714	Front Bumper Brace - TC4/NTC3	\$14.99

Website information: <http://www.penguinrc.com/products/associated.html>



HPI

Items from a chassis set, replacement or optional parts list indicated with a * can be used directly upon the base car without the need of additional parts.

Pro3

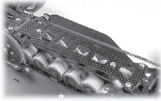
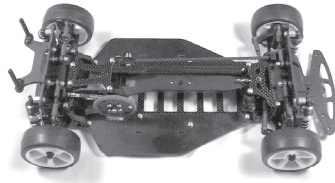

P3010

P3000 Performance Chassis

Sale!!! \$79.99

Replacement Parts

P3001	P3000 Main Chassis Plate	\$58.99
P3002	P3000 G10 Side Plate	\$7.99
P3003*	P3000/Pro3 Front Bulkhead Brace Kit	\$7.99
P3004*	P3000/Pro3 Rear Bulkhead Brace Kit	\$16.99
P3005	P3000 Longitudinal Brace Plate	\$9.99
P3006*	P3000/Pro3 Front Shock Tower <i>(requires P3008)</i>	\$10.99
P3007*	P3000/Pro3 Rear Shock Tower <i>(requires P3008)</i>	\$13.99
P3008	P3000 Shock Tower Hardware Kit	\$14.99

Optional Parts

P3002g	P3000 Graphite Side Plate Set	\$29.99
P3010	P3000 Racing Upgrade Kit <i>(includes Full Upper Deck)</i>	\$23.99

Website information: <http://www.penguinrc.com/products/hpi/p3000.html>

Pro2/ Sport2



P3700

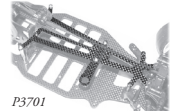

P3701

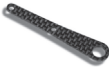

P3702



P3703



P3704

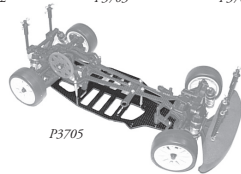

P3705



P3706

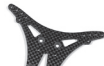

P3707



P3708

Performance Parts

P3700	ProStrap System	SALE!!! \$8.49
P3701	aDeck Upper Deck System <i>(includes P3702)</i>	\$26.99
P3702	Transponder Mount	\$3.99
P3703	Chassis Stiffener Post Set	\$5.99
P3704	1mm CG Lowering Kit	\$4.99
P3705	Performance Lower Chassis	\$57.99
P3706	Front Shock Tower	\$5.99
P3707	Rear Shock Tower	\$11.99
P3708	Front Body Mount Brace Kit	\$7.99
P3708a	P3708 Graphite Support Braces (x4)	\$12.99

Website information: <http://www.penguinrc.com/products/hpi.html>

Other

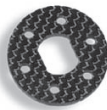

P3710

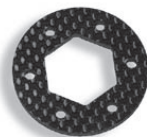

P3711

additional items for other vehicles

P3710	Performance Brake Disc - Medium <i>(RS4)</i>	\$5.99
P3711	Performance Brake Disc - Large <i>(Savage)</i>	\$6.99

Website information: <http://www.penguinrc.com/products/hpi.html>



HPI

Items from a chassis set, replacement or optional parts list indicated with a * can be used directly upon the base car without the need of additional parts.

Micro



P3500el

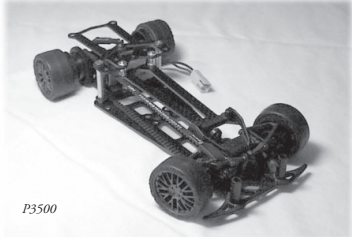

P3500

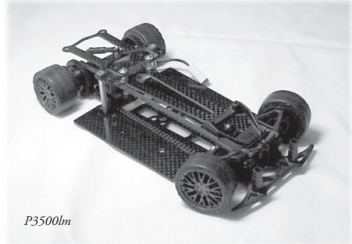

P3500lm



P3502s

P3503

P3508



P3504l

P3509a

P3509c

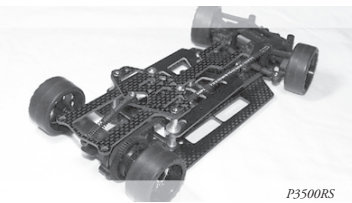

P3500RS

P3500el Entry-Level Chassis

\$14.99

P3500 Performance Chassis

\$54.99

P3500lm LeMans Performance Chassis \$64.99

Replacement Parts

P3501	P3500 Narrow Chassis Plate (<i>P3500 kit standard</i>)	\$23.99
P3501lm	P3500 Wide Chassis Plate (<i>P3500lm kit standard</i>)	\$33.99
P3502	P3500 Upper Deck (<i>P3500 kit standard</i>)	\$8.99
P3502v	P3500 Vertical Servo Upper Deck (<i>P3500lm kit standard</i>)	\$10.99
P3503*	P3500/micro Rear Deck Kit (<i>VCS Compatible</i>)	\$24.99
P3504	P3500 Rear Pod Kit	\$12.99
P3505	P3500 Center Battery Plate	\$3.99
P3507a	P3500 Graphite High Roll Plate Kit (<i>P3500 kit standard</i>)	\$8.99
P3507b	P3500 Graphite Low Roll Plate Kit (<i>P3500lm kit standard</i>)	\$8.99

Optional Parts

P3502s*	P3500/micro Standard Upper Deck	\$10.99
P3504l	P3500 400 Motor Kit (<i>includes Long Rear Pod</i>)	\$16.99
P3505	P3500 Center Battery Plate	\$3.99
P3508*	P3500/micro Mini/Micro Servo Plate	\$3.99
P3508m180*	P3500/micro Graphite Motor Plate (<i>180 size</i>)	\$5.99
P3508m300*	P3500/micro Graphite Motor Plate (<i>300 size</i>)	\$5.99
P3508m400*	P3500/micro Graphite Motor Plate (<i>400 size</i>)	\$5.99
P3506a	P3500 G10 High Roll Plate Kit	\$8.99
P3506b	P3500 G10 Low Roll Plate Kit	\$8.99
P3507a	P3500 Graphite High Roll Plate Kit	\$8.99
P3507b	P3500 Graphite Low Roll Plate Kit	\$8.99
P3509a	P3500 Saddle Pack Plate Kit (<i>P3500lm and P3500el only</i>)	\$8.99
P3509b	P3500 Bullet Saddle Pack Plate Kit (<i>P3500lm and P3500el only</i>)	\$8.99
P3509c	P3500 8-cell Saddle Pack Plate Kit (<i>P3500lm and P3500el only</i>)	\$10.99

Website information: <http://www.penguinrc.com/products/hpi/p3500el.html>

<http://www.penguinrc.com/products/hpi/p3500.html>

<http://www.penguinrc.com/products/hpi/p3500lm.html>

<http://www.penguinrc.com/products/hpi/p3503.html>

P3500RS Hi-Performance Chassis

\$74.99

Replacement Parts

P3501rs	P3500rs Chassis Plate	\$28.99
P3502rs	P3500rs Upper Deck	\$8.99
P3503rs	P3500rs Rear Deck Kit (<i>VCS Compatible</i>)	\$28.99
P3504	P3500 Rear Pod Kit	\$12.99
P3505rs	P3500rs Battery Plate Kit	\$13.99
P3507a	P3500 Graphite High Roll Plate Kit	\$8.99
P3508m180*	P3500/micro Graphite Motor Plate (<i>180 size</i>)	\$5.99

Optional Parts

P3505	P3500 Center Battery Plate	\$3.99
P3506a	P3500 G10 High Roll Plate Kit	\$8.99
P3506b	P3500 G10 Low Roll Plate Kit	\$8.99
P3507a	P3500 Graphite High Roll Plate Kit	\$8.99
P3507b	P3500 Graphite Low Roll Plate Kit	\$8.99
P3508*	P3500/micro Mini/Micro Servo Plate	\$3.99
P3508m300*	P3500/micro Graphite Motor Plate (<i>300 size</i>)	\$5.99
P3508m400*	P3500/micro Graphite Motor Plate (<i>400 size</i>)	\$5.99
P3509rs	P3500rs 8th Cell Assembly Jig	\$4.99

Website information: <http://www.penguinrc.com/products/hpi/p3500rs.html>



Mugen-Seiki

MTX2

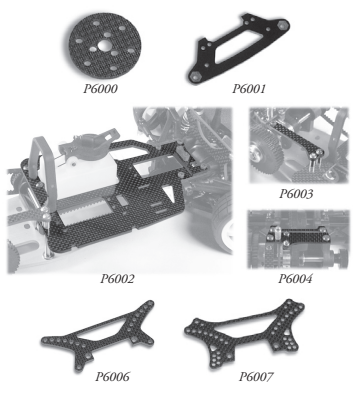

Performance Parts

P6000	Performance Brake Disc	\$4.99
P6001	Front Bumper Brace	\$4.99
P6002	Performance Upper Deck	\$39.99
P6003	Graphite Center Support	\$6.99
P6004	Rear Bulkhead/Brake Support	\$8.99
P6006	Front Shock Tower	\$15.99
P6007	Rear Shock Tower	\$16.99

Website information: http://www.penguinrc.com/products/mugen_seiki.html

MTX3

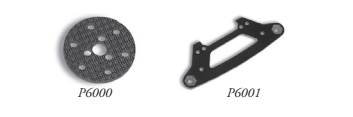

Performance Parts

P6000	Performance Brake Disc (requires 2)	\$4.99
P6001	Front Bumper Brace	\$4.99

Website information: http://www.penguinrc.com/products/mugen_seiki.html

Impulse

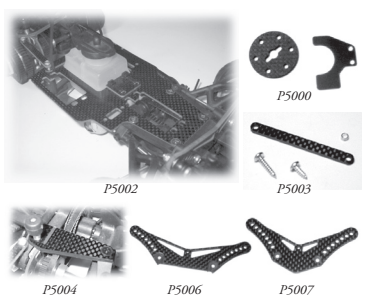

Performance Parts

P5000	Performance Brake Disc	\$5.99
P5002	Performance Upper Deck	\$29.99
P5003	Graphite Center Support	\$4.99
P5004	Rear Bulkhead/Brake Support	\$9.99
P5006	Front Shock Tower	\$9.99
P5007	Rear Shock Tower	\$10.99

Website information: <http://www.penguinrc.com/products/serpent.html>

Serpent



Tamiya

Items from a chassis set, replacement or optional parts list indicated with a * can be used directly upon the base car without the need of additional parts.

TA-05

TB-01

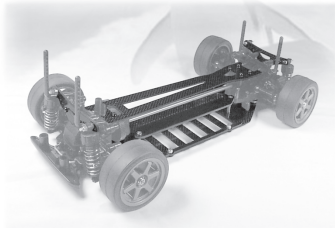

TLT-1



P2308



P9000

Other



P2700



P2705

P2020 Performance Chassis

coming soon...

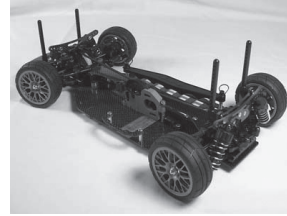

P2100 Performance Chassis

\$89.99

Replacement Parts

P2101	P2100 Main Chassis Plate	\$50.99
P2102*	P2100/TB01 Upper Chassis Plate	\$21.99
P2103	P2100 Bulkhead Plate (for front or rear)	\$5.99
P2104	P2100 Steering Spacer Tie Set	\$10.99
P2105	P2100 Battery Bar Set	\$14.99
P2106*	P2100/TB01 Front Shock Tower	\$9.99
P2107*	P2100/TB01 Rear Shock Tower	\$9.99

Website information: <http://www.penguinrc.com/products/tamiya/p2100.html>

P2300 Performance Chassis

\$129.99

P2300r Magnum Performance Chassis **\$159.99**

(note: P2300r is for use with the Traxxas Magnum Gearbox Parts - Additional Purchases from Traxxas are required for use.)

Replacement Parts

P2301	P2300 Chassis Plate Set	\$62.99
P2302	P2300 Radio Tray Kit	\$7.99
P2302r	P2300r Radio Tray Kit	\$15.99
P2303	P2300 Skid Plate Kit	\$10.99
P2304	P2300 Gearbox Set	\$29.99
P2304r	P2300r Gearbox Set	\$28.99
P2305	P2300 Motor Plate Set	\$14.99
P2305r	P2300r Motor Plate Set	\$25.99
P2306	P2300 Front Battery Tray Kit	\$13.99
P2307	P2300 Rear Battery Tray Kit	\$15.99
P2308*	P2300/TLT-1 Servo Kit (for front or rear)	\$23.99

Optional Parts

P2300rGB	P2300 Magnum Gearbox Upgrade Plate Set	\$54.99
P2303a	P2300 Replacement Skid Plate	\$3.99
P2308*	P2300/TLT-1 Servo Kit (for front or rear)	\$23.99
P9000	Velcro™ Straps (x2)	\$4.99

Website information: <http://www.penguinrc.com/products/tamiya/p2300.html>

Website information: <http://www.penguinrc.com/products/tamiya/p2300s.html>

additional items for other vehicles

P2700	Performance Brake Disc - Nitro (TG10, TGX, and similar)	\$6.99
P2701	Front Shock Tower - TG10/TB01	\$9.99
P2702	Rear Shock Tower - TG10/TB01	\$9.99
P2703	Steering Spacer Tie Kit - TG10/TB01	\$10.99
P2705	Front One-Way Adaptor Plate - EVOIII/TB02	\$6.99

Website information: <http://www.penguinrc.com/products/tamiya.html>



Team Losi

XX4



Performance Parts

P4700	Shock Tower Brace Set	\$19.99
P4700a	Front Shock Tower Brace	\$13.99
P4700b	Rear Shock Tower Brace	\$14.99

Website information: <http://www.penguinrc.com/products/losi/p4700.html>

XXX

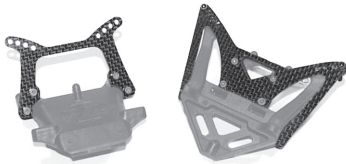

Performance Parts

P4705	Front Shock Tower & Rear Brace Set	\$21.99
P4705a	Front Shock Tower	\$11.99
P4705b	Rear Shock Tower Brace	\$17.99

Website information: <http://www.penguinrc.com/products/losi/p4705.html>

XXXNT

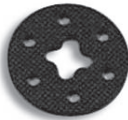

Performance Parts

P4710	Performance Brake Disc	\$3.99
-------	------------------------	--------

Website information: <http://www.penguinrc.com/products/losi.html>

Other



P6700

P6701

additional items for other vehicles

P6700	Performance Brake Disc - small (<i>4tec, stampede, rustler, sport</i>)	\$3.99
P6701	Performance Brake Disc - large (<i>tmaxx, monster buggy</i>)	\$6.99

Website information: <http://www.penguinrc.com/products/traxxas.html>

Traxxas



Yokomo

Items from a chassis set, replacement or optional parts list indicated with a * can be used directly upon the base car without the need of additional parts.

MR4

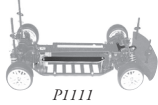
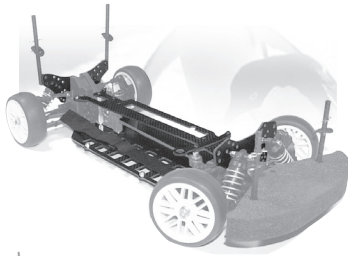

P1111

P1110 Performance Chassis

\$99.99

Replacement Parts

P1101	P1100 Main Chassis Plate	\$62.99
P1102*	P1100/MR4 Upper Deck Plate	\$27.99
P1103	P1100 Chassis Standoff Set	\$7.99
P1104	P1100 Steering Spacer Set	\$3.99
P1105	P1100 Battery Hold Down Kit	\$7.99
P1106*	P1100/MR4 Front Shock Tower	\$12.99
P1106r*	P1100/MR4 Rally Front Shock Tower	\$11.99
P1107*	P1100/MR4 Rear Shock Tower	\$15.99
P1108*	P1100/MR4 Transponder Mount	\$4.99

Optional Parts

P1110	P1100 Racing Transponder Mount	\$6.99
P1111	P1100 Racing Upgrade Kit	\$23.99

Website information: <http://www.penguinrc.com/products/yokomo/p1100.html>

MR4_{BC/MT}

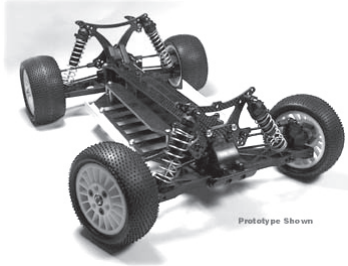

Prototype Shown

P1115 Performance Chassis special order \$124.99

Replacement Parts

P1101	P1100/MR4 Main Chassis Plate	\$62.99
P1102*	P1100/MR4 Upper Deck Plate	\$27.99
P1103	P1100 Chassis Standoff Set	\$7.99
P1104	P1100 Steering Spacer Set	\$3.99
P1111	P1100 Racing Upgrade Kit	\$23.99
P1116*	P1115 Front Shock Tower	special order \$16.99
P1117*	P1115 Rear Shock Tower	special order \$26.99
P1118	P1115 BC Body Mount Kit	\$8.99

Website information: <http://www.penguinrc.com/products/yokomo/p1115.html>

GT4

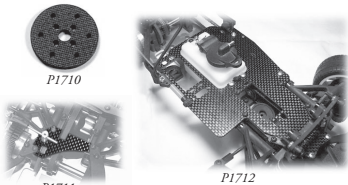

P1710



P1711

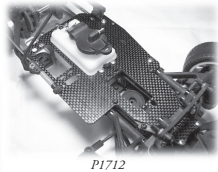

P1712



P1713



P1714



P1716

Performance Parts

P1710	Performance Brake Disc	\$6.99
P1711	Rear Bulkhead Plate	\$6.99
P1712	Performance Upper Deck	\$38.99
P1713	Front Shock Tower/Brace	\$6.99
P1714	Rear Shock Tower/Brace	\$6.99
P1716	Front Bumper Brace	\$8.99

Website information: <http://www.penguinrc.com/products/yokomo.html>

Other



P1700



P1701



P1702

additional items for other vehicles

P1700	Quadslot - YR4 M2/Team	SALE!!! \$11.49
P1701	Quadslot Velcro - YR4 M2/Team	SALE!!! \$10.49
P1702	ProStrap System - YR4 Pro/J-type	SALE!!! \$8.49

Website information: <http://www.penguinrc.com/products/yokomo.html>



XRay

M18

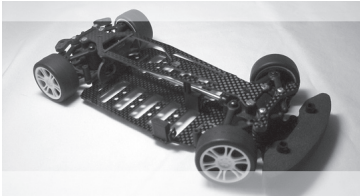

P7500

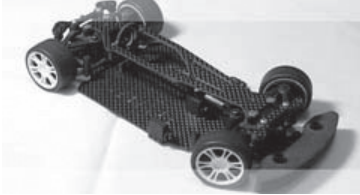

P7500s

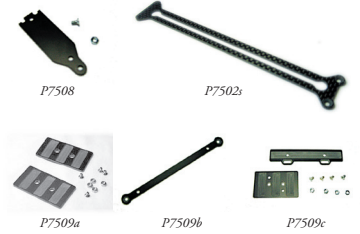

P7508

P7502s

P7509a

P7509b

P7509c

P7500 Performance Chassis **\$56.99**
P7500s 140mm Performance Chassis **\$64.99**

Replacement Parts

P7501*	P7500/M18 Main Chassis Plate	\$43.99
P7501s	P7500s 140mm Main Chassis Plate	\$39.99
P7502*	P7500/M18 Upper Deck Plate	\$16.99
P7502ss	P7500s Upper Deck Plate	\$16.99
P7504m180	P7500 Graphite Side Mount Motor Plate (180size)	\$5.99
P7504s	P7500s 140mm Graphite Drive Shaft	\$9.99
P7505m180	P7500 Graphite Vertical Mount Motor Plate (180size)	\$5.99
P7506*	P7500/M18 Front Shock Tower	\$8.99
P7507*	P7500/M18 Rear Shock Tower	\$8.99

Optional Parts

P7502s*	P7500/M18 Standard Style Upper Deck Plate	\$11.99
P7504m300	P7500 Graphite Side Mount Motor Plate (300size)	\$5.99
P7505m180	P7500 Graphite Vertical Mount Motor Plate (180size)	\$5.99
P7505m300	P7500 Graphite Vertical Mount Motor Plate (300size)	\$5.99
P7508	P7500 Radio Tray	\$3.99
P7508m400	P7500 400 Motor Upgrade Kit (limited availability)	\$22.99
P7509a	P7500 6-cell Saddle Pack Plate Kit	\$8.99
P7509b	P7500 6-cell Stick Pack Plate Kit	\$3.99
P7509c	P7500 6-cell Hybrid Bullet/Saddle Pack Plate Kit	\$8.99
P7509d	P7500 5-cell LTO Pack Plate Kit	\$8.99

Website information: <http://www.penguinrc.com/products/xray/p7500.html>

Website information: <http://www.penguinrc.com/products/xray/p7500s.html>

Material

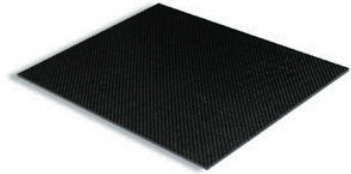

Graphite/G10 Plate **special order...**

M1.0	1.0mm 7x9" Graphite Plate - increment	\$24.49
M1.5	1.5mm 7x9" Graphite Plate - increment	\$26.49
M2.0	2.0mm 7x9" Graphite Plate - increment	\$28.49
M2.5	2.5mm 7x9" Graphite Plate - increment	\$32.49
M3.0	3.0mm 7x9" Graphite Plate - increment	\$36.49
M4.0	4.0mm 7x9" Graphite Plate - increment (limited availability)	\$46.49
M1.0f	1.0mm 7x9" G10 Plate - increment	\$3.99
M1.5f	1.5mm 7x9" G10 Plate - increment	\$4.99
M2.0f	2.0mm 7x9" G10 Plate - increment	\$5.99
M2.5f	2.5mm 7x9" G10 Plate - increment	\$6.99
M3.0f	3.0mm 7x9" G10 Plate - increment	\$8.99
M5.0f	5.0mm 7x9" G10 Plate - increment (limited availability)	\$11.99

Website information: <http://www.penguinrc.com/products/other.html>

Plate increments may be combined to create larger plates... ie 9x14" = 2 plates, 14x18" = 4 plates

Misc.

Screw and other part packages

Please visit http://www.penguinrc.com/ordering/quickshop/other_quickshop.html for a complete listing of screw and accessory packages that cover replacements for all of our products.

Items from a chassis set, replacement or optional parts list indicated with a "*" can be used directly upon the base car without the need of additional parts.



1230-P N Jefferson Street
Anaheim CA 92807
714.630.9015
714.630.6250 FAX
support@penguinrc.com
<http://www.penguinrc.com>

Summer 2006



About Penguin *r/c* :

Penguin *r/c* was founded in April of 1997 to provide the *r/c* industry the most advanced products and accessories possible. The goal of Penguin *r/c* is to provide customers with the information and products to allow them to get the most enjoyment from their vehicles and a competitive advantage during competition.

Penguin *r/c* product and set-up information can be found on the web at www.penguinrc.com. Advertising for Penguin *r/c* can be found in R/C Car Action and R/C Car magazines with future expansion into further publications.

©2006 Penguin *r/c*